

Sink Happy Hour Gun Metal

Kitchen Sinks

Code: 1049 856



DETAILS

Coloring Gun Metal

Texture Brushed in line

Finish PVD

Material AISI 304 stainless steel

Edge/Installation Type Undermount

Dimensions 1236x503 mm

Standard fittings Fixing hooks, gasket, drain, overflow and siphon, boxed packing

Mixer holes No standard holes

Built-in hole 1185x477 mm

Drainer No

Width 123.6 cm

Bowl dimension 1185x400 mm

Number of bowls 1 bowl

Waste fitting 3,5" drain

EQUIPMENT

1 x Black Grid 8100 600
1 x Bamboo chopping board
8200 002

FEATURES

Gun Metal The Gun Metal finish is obtained by treating steel with a physical process called PVD (Physical Vacuum Deposition) which deposits particles of noble metals on the surface. The result is a unique and refined aesthetic effect, and an improvement of the mechanical properties of the steel which is more resistant to impact and scratches.

Diamond-shape bottom The draining of water is an important feature in a sink, and it's always taken good care of in Foster products. In the bent-welded sinks, which would have a flat bottom, the proper draining is guaranteed by the elegant beveling, which helps the water flow.

High thickness 1mm thick steel. A significant thickness, which guarantees the maximum sturdiness and durability.

Triple recess - sliding accessories The Foster Milano sink has an ingenious design that makes it simple to use a large set of optional accessories. On the topmost supporting step, the innovative Black grids slide, creating a large and practical surface to rinse food and crockery. The second step is meant to support and allow the sliding of a complete combination of accessories, which make some operations practical and safe: rinse, drain, slice, grate... everything can be done inside the sink. The third supporting step is on the bottom of the bowl. On this step one can rest the Black grids, making it possible to rinse foodstuffs without their coming in contact with the bottom of the sink, which may be dirty.

Perimetral overflow

The overflow is always a security on the Foster sinks that prevents the overflow of water in case of oversights. The perimeter drain solution improves aesthetics thanks to its square and essential shape.

TECHNICAL DATA

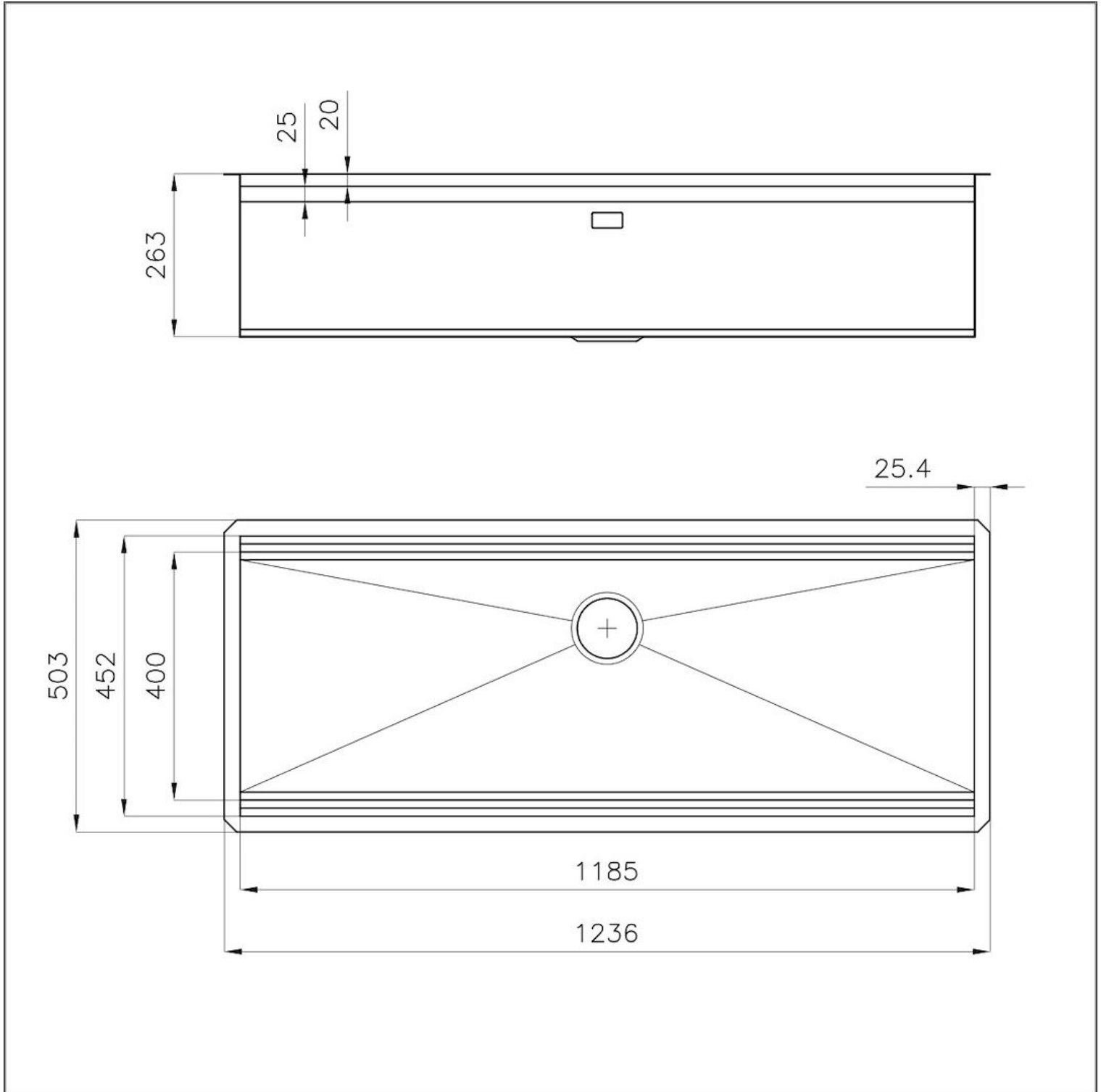

Happy Hour Optional accessories / Accessori opzionali

The "rails" system makes it possible to use a combination of numerous accessories. Grids, chopping boards, utensils' ranging system, bowls and containers of different dimensions can be alternated in the workspace with a simple gesture, and can easily be stacked, in order to be on hand at all times.

Il sistema di "corsie" rende possibile l'utilizzo combinato di innumerevoli accessori. Griglie, taglieri, portautensili, vaschette e contenitori di varie dimensioni si alternano nella zona di lavoro con un semplice gesto e possono essere impilati, sempre a portata di mano.

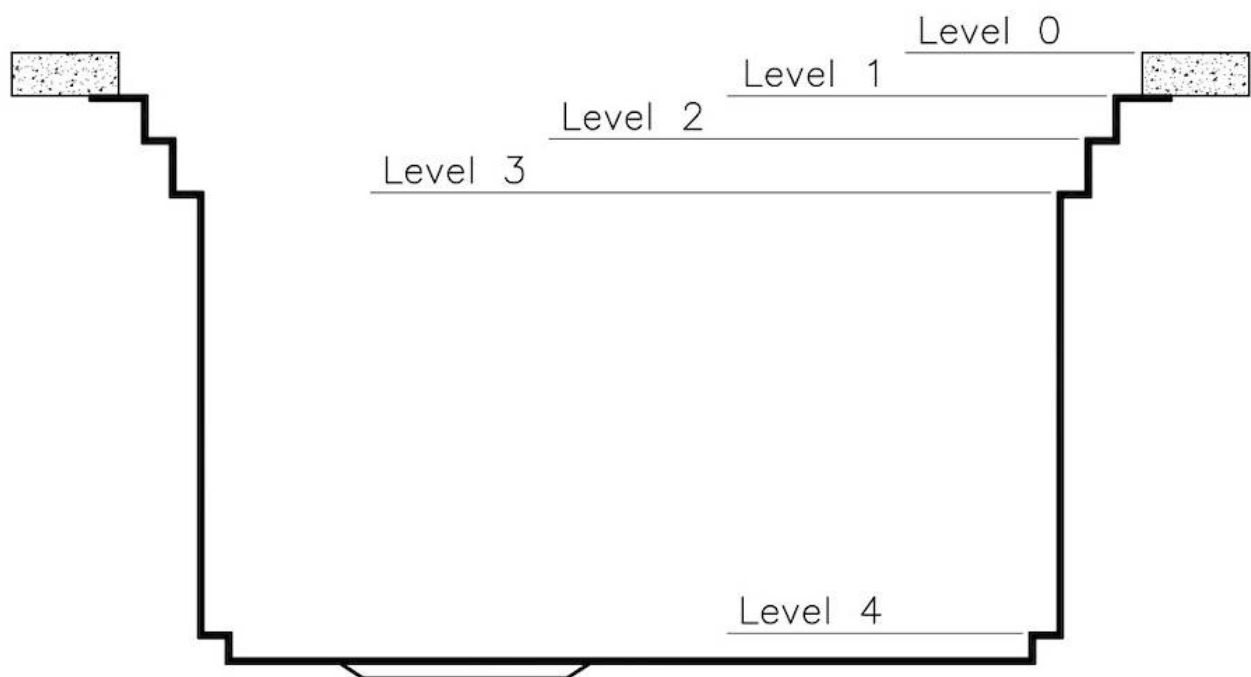

Happy Hour Level 0

Compatible accessories/Accessori compatibili:

8200 002

8200 601



Happy Hour Level 1

Compatible accessories/Accessori compatibili:

8100 625

8100 626

8100 627



Happy Hour Level 2

Compatible accessories/Accessori compatibili:

8100 600
8100 620
8100 621
8100 622
8100 628
8642 000



Happy Hour Level 3

Compatible accessories/Accessori compatibili:

8644	101
8153	100
8631	300
8200	002
8200	601
8100	623
8100	624



Happy Hour Level 4

Compatible accessories/Accessori compatibili:

8100 600





GALLERY

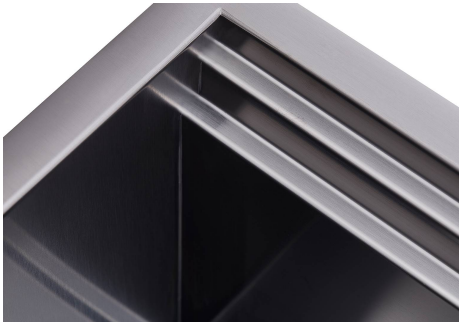
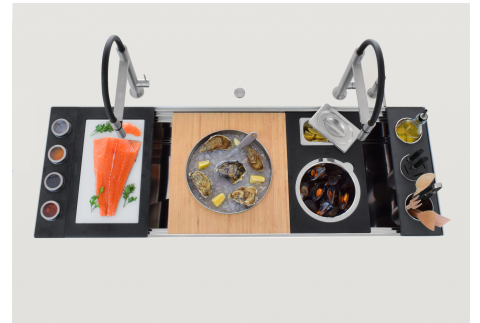
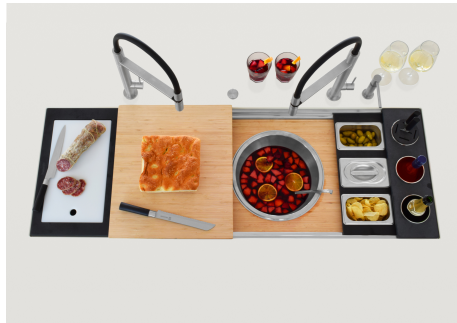
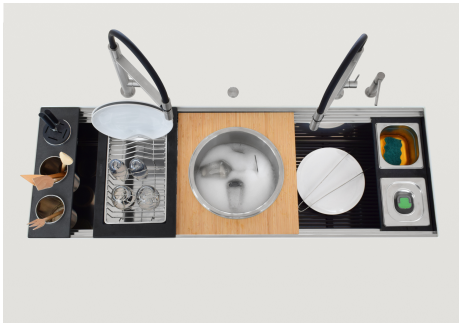

EQUIPMENT



Bamboo chopping board
8200 002



Black grid
8100 600

OPTIONAL ACCESSORIES



2 Bowls set
8100 623



3 Bottles-holder set
8100 621



3 Bottles-holder set
8100 626



3 Bowls set
8100 622



3 Bowls set
8100 624



4 Spices-holder set
8100 620



4 Spices-holder set
8100 625



Glass chopping board
8631 300



Graters kit with ring-holder and food collection tray

8159 101

* only in combination with the accessory
8100 627 or 8644 101



HDPE + Black Twin chopping board
8100 627



HPDE Twin chopping board
8644 101



Kit bowl Ø30 cm with bamboo support
8200 601



Kit multi-bowl
8100 628



Knives-holder
8100 030

* only in combination with the accessory
8100 621 or 8100 626



Stainless steel perforated tray
8151 000

* only in combination with the accessory
8100 627 or 8644 101

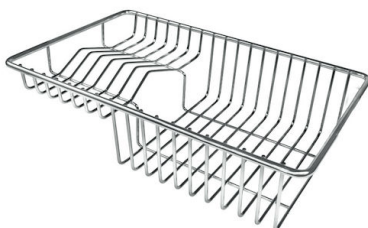

Stainless steel plate rack
8100 303

* only in combination with the accessory
8100 627 or 8644 101



Steel tray
1778 000

* only in combination with the accessory
8200 601



Walnut-wood chopping board
8642 000



White bowl
8153 100



**Stainless steel perforated tray PVD
Gun Metal**

8151 006

* only in combination with the accessory
8644 101



Foldable rack black
8110 010

RECOMMENDED PAIRINGS

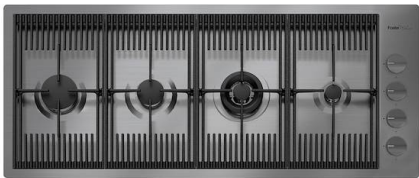

Cooker hob Milanello Gun Metal
7681 006



Dispenser Evo Gun Metal
8520 856



Mixer Tap Omega Gun Metal
8497 856



Mixer Tap Skin Gun Metal
8424 856



**Space Push Gun Metal automatic
waste fitting - PO**
8407 120



VOLTA GUN METAL
8491 106